

NORD

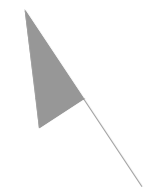

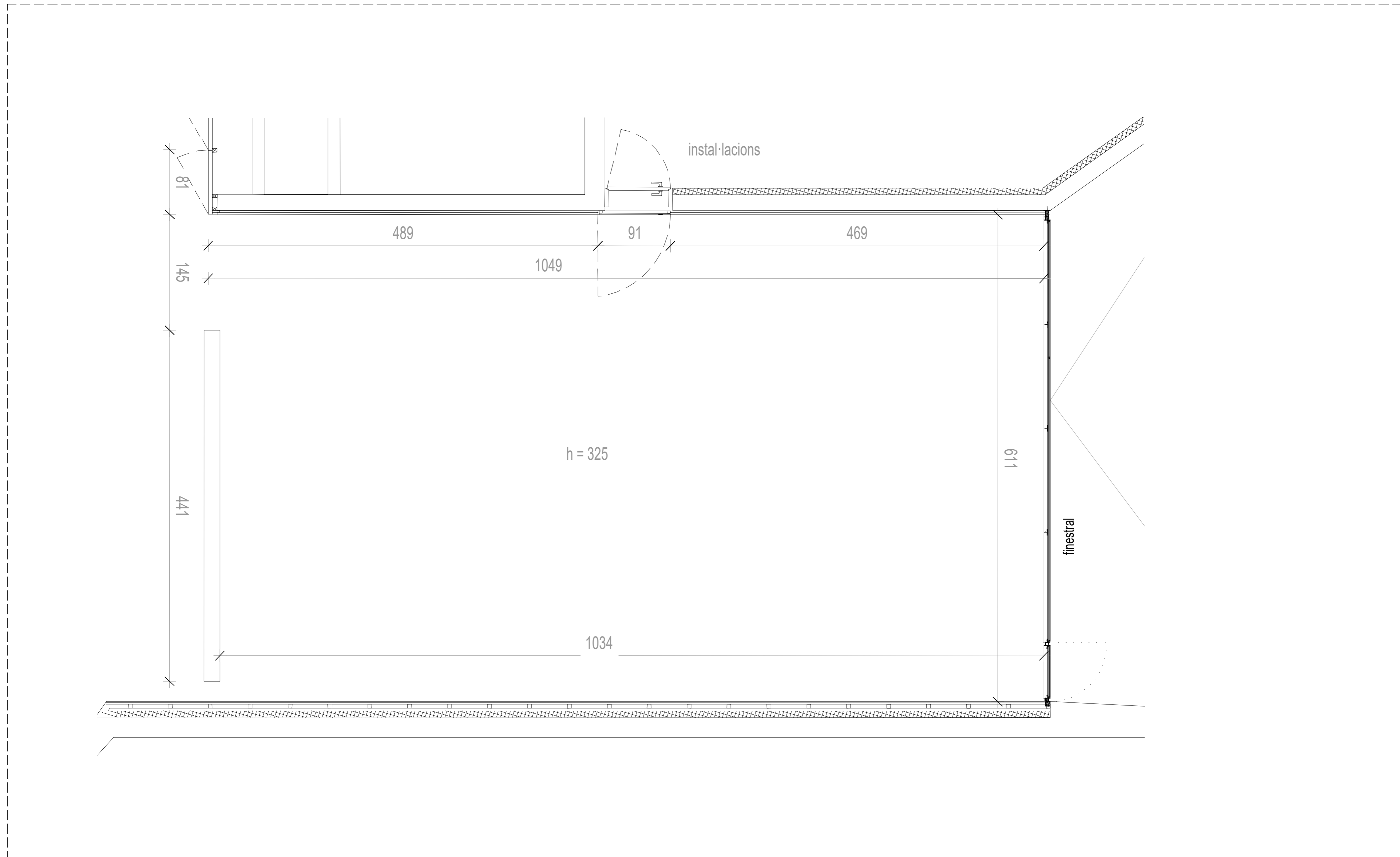

UNITATS: CENTÍMETRES

CF - SALA TEMPORALS P1  
65 m2 / alçada 3,25m

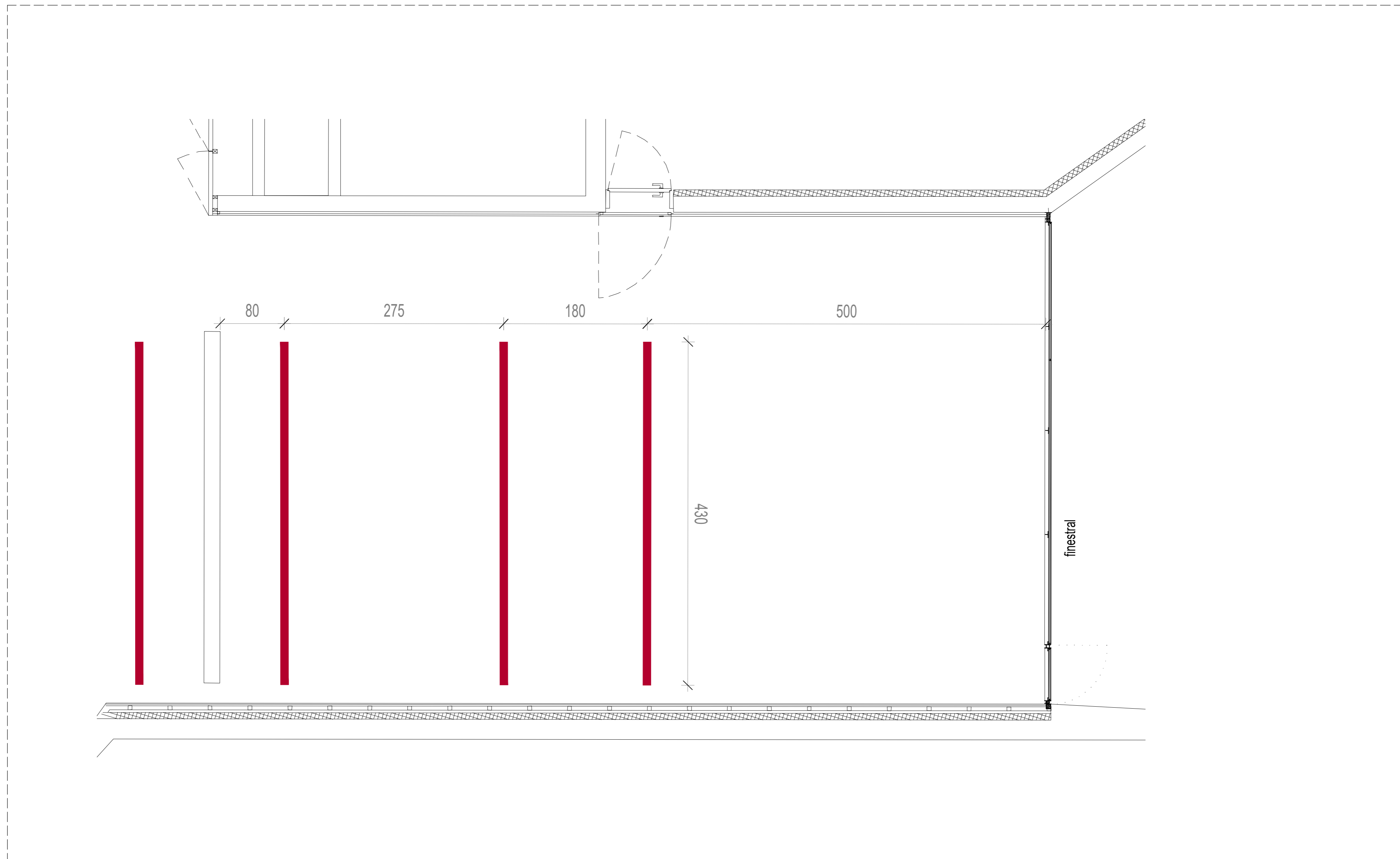

UNITATS: CENTÍMETRES

CF - SALA TEMPORALS P1  
Carrils focus

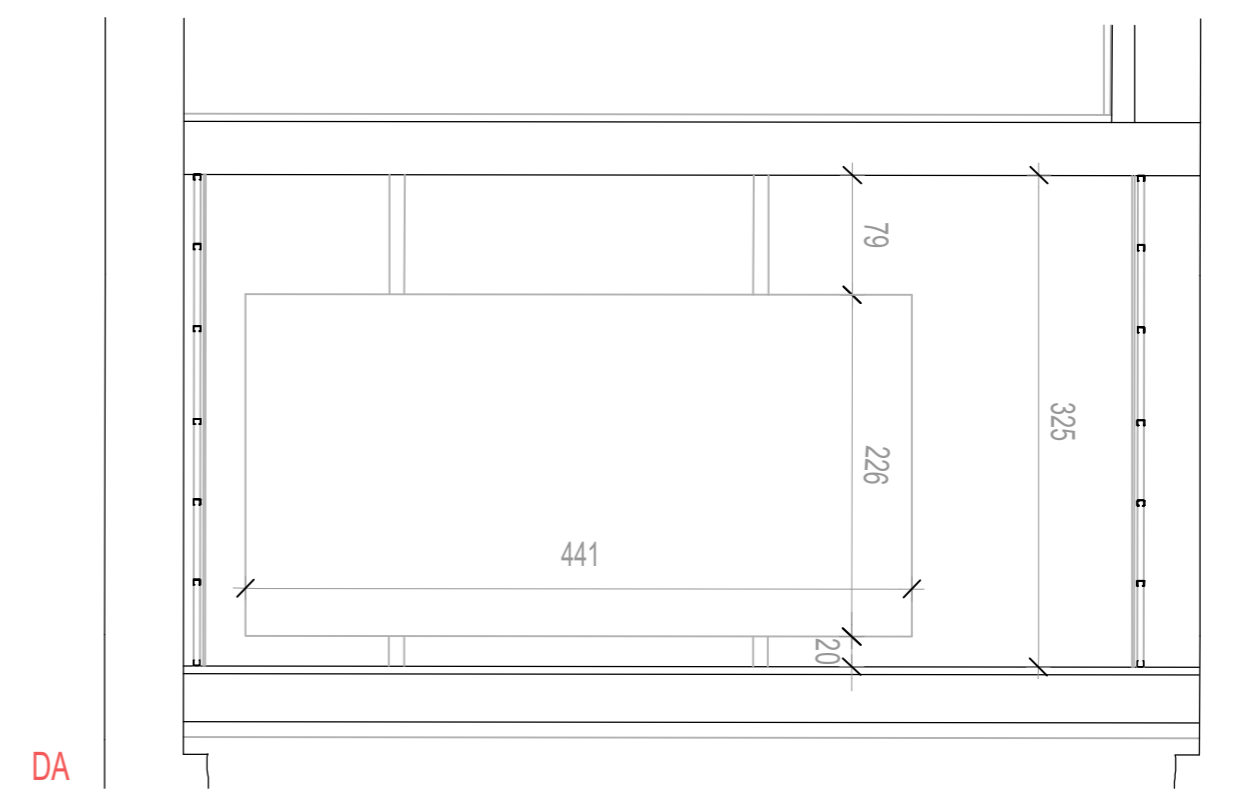
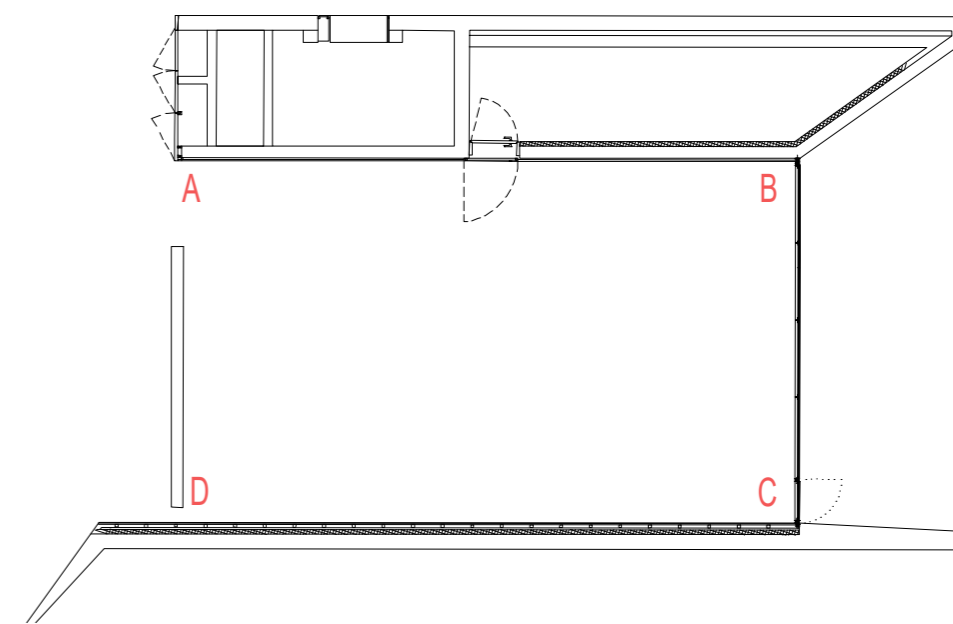
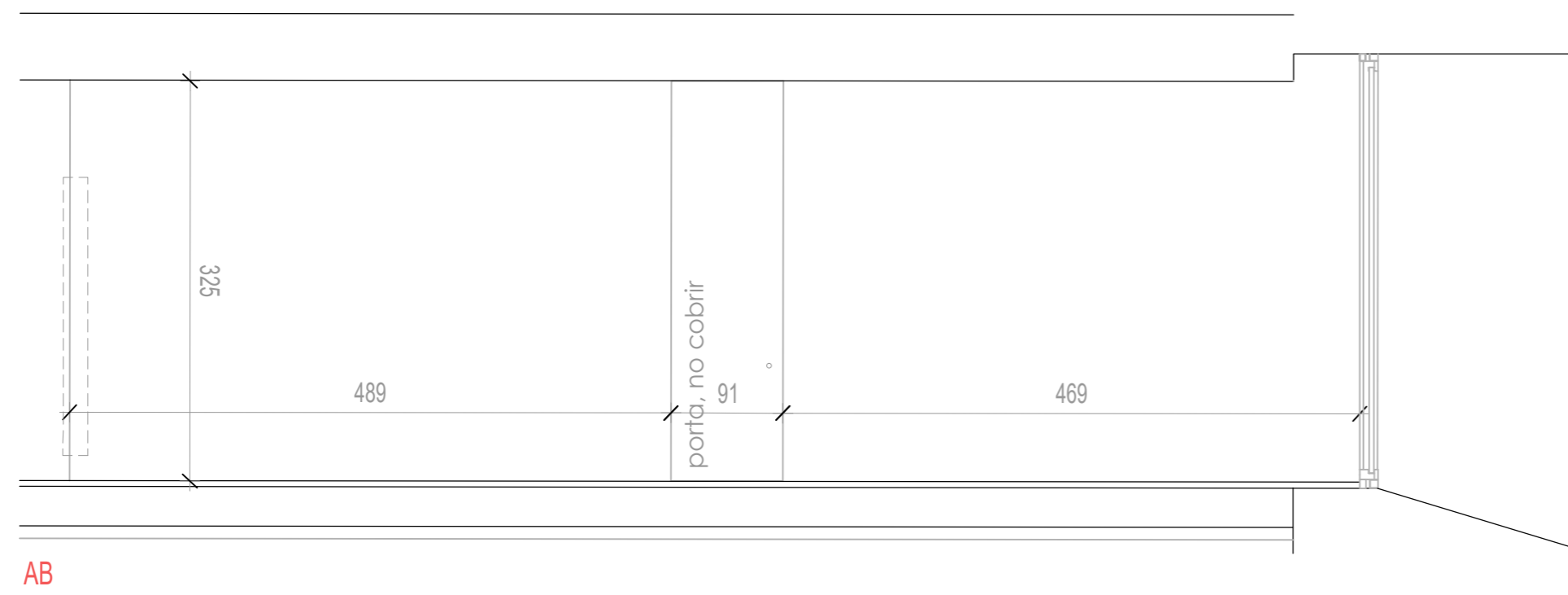

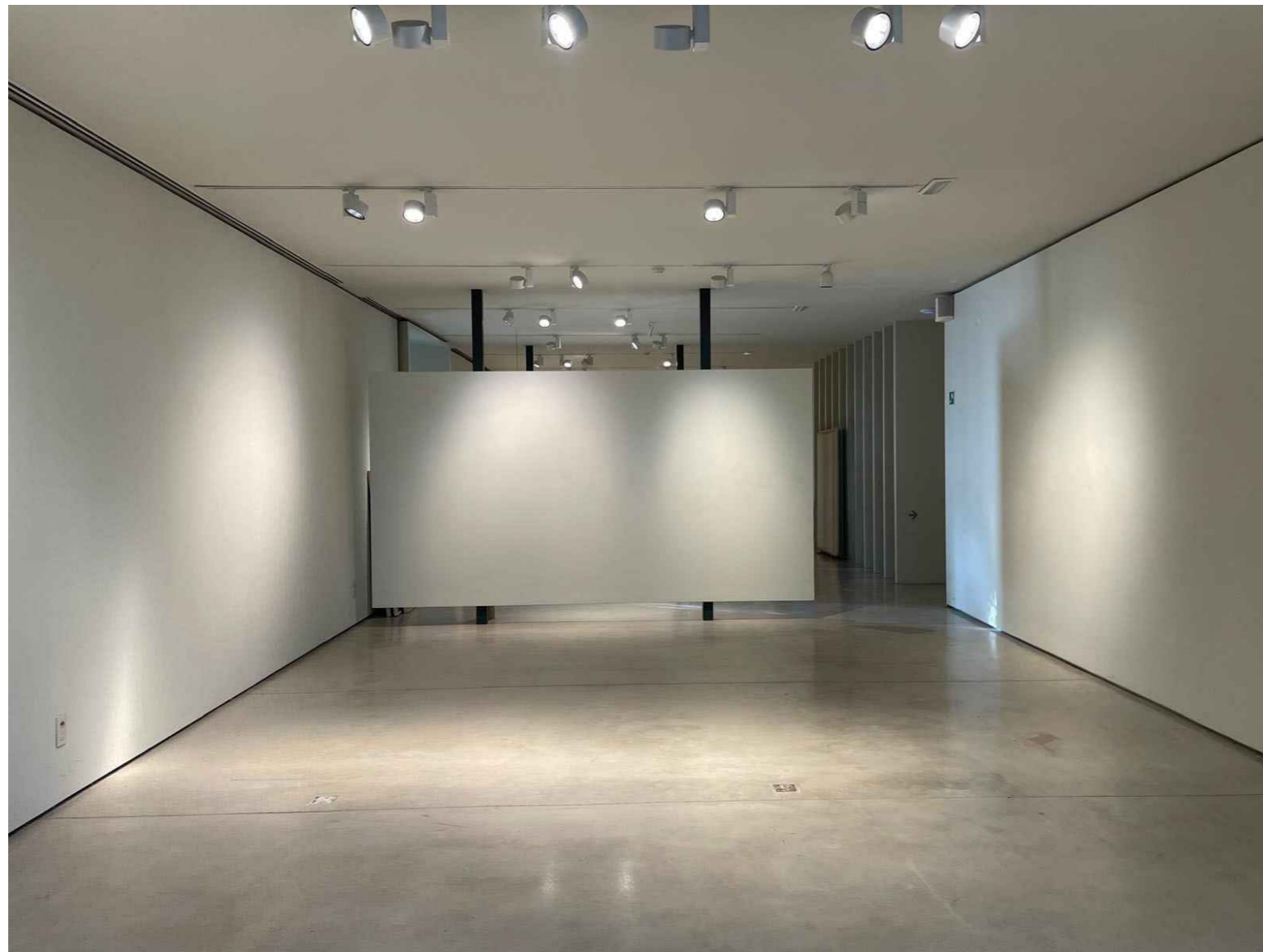

1.

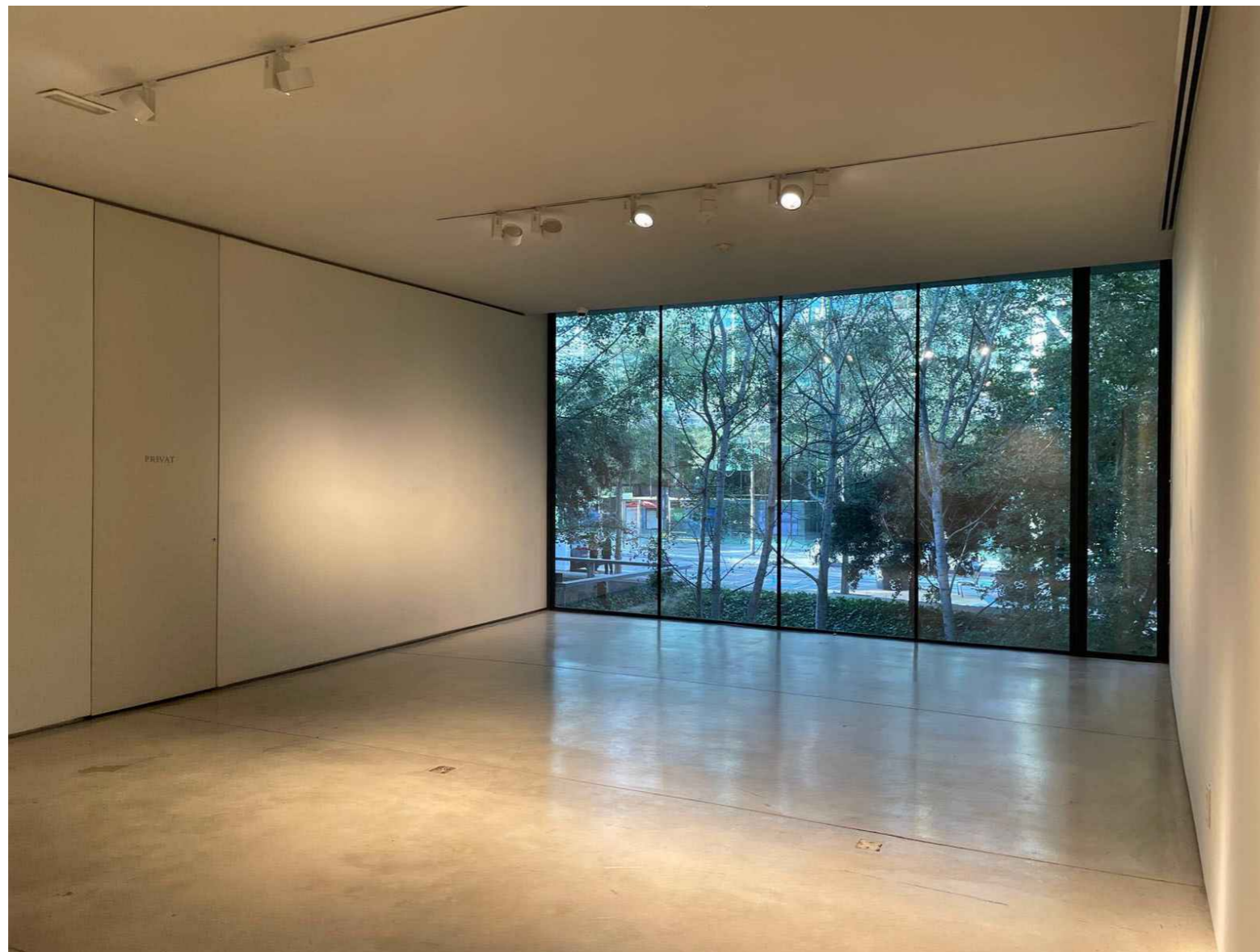
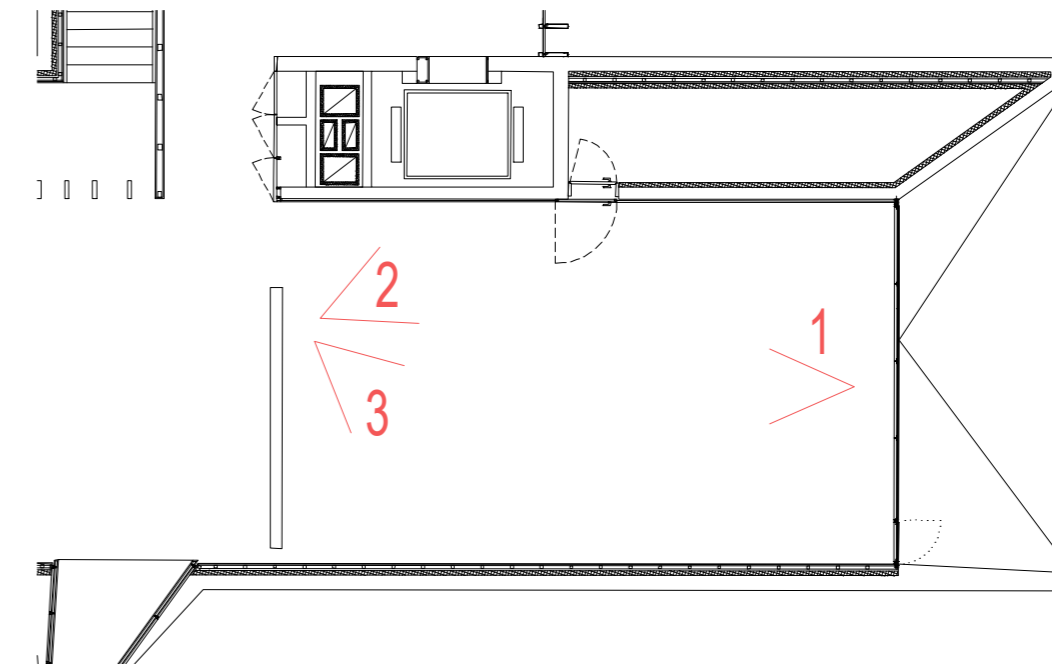

2.

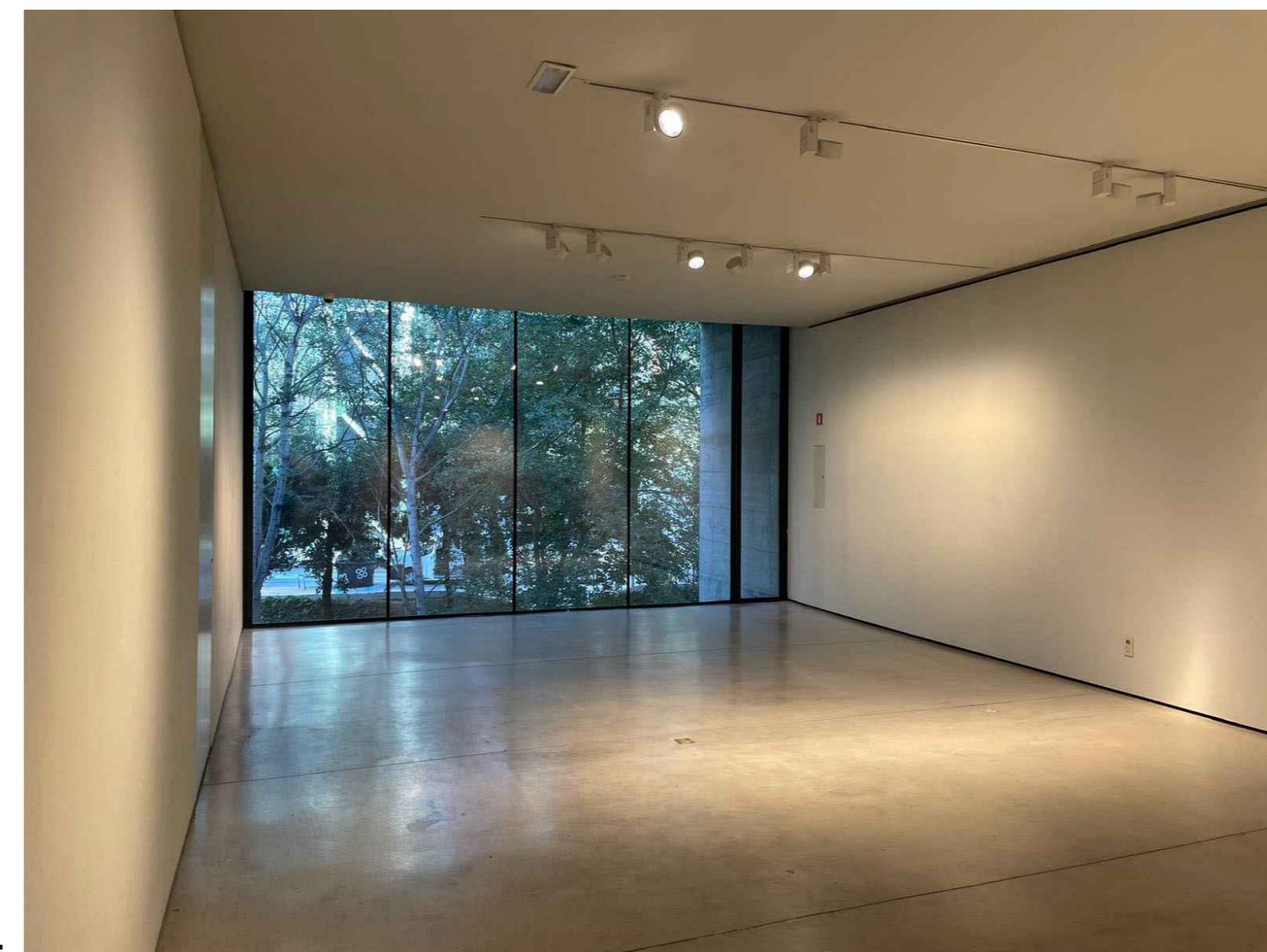

3.